

# KIT/301-08LB-W/6\*2122SR3-F40W-D



## Key Features

### **NVR301-08LB-W**

- Embedded WiFi Module with high-performance and high stability
- Support CCMP encryption and WPA2-PSK authentication, Support IP cameras with WiFi in access
- Support Ultra 265/H.265/H.264 video formats
- 8-channel input
- Third-party IP cameras supported with ONVIF conformance: Profile S, Profile G, Profile T
- Support 1-ch HDMI, 1-ch VGA
- HDMI and VGA synchronous outputs provided
- Up to 1080p resolution recording
- 1 SATA HDD, Up to 6TB for each HDD
- ANR technology to enhance the storage reliability when the network is disconnected
- Support cloud upgrade

**IPC2122SR3-F40W-D**

- Day/night functionality
- Smart IR , up to 30 m (98 ft) IR distance
- Optical glass window with higher light transmittance
- IR anti-reflection window to increase the infrared transmittance
- 2D/3D DNR (Digital Noise Reduction)
- Ultra 265,H.265, H.264, MJPEG
- Triple streams
- ONVIF Conformance
- Wide temperature range: -30°C ~ +60°C (-22°F ~ 140°F)
- Wide voltage range of ±25%
- IP66

## Specifications

<b>Model</b>	<b>NVR301-08LB-W</b>
<b>Video/Audio Input</b>	
IP Video Input	8-ch
<b>Network</b>	
Incoming Bandwidth	40Mbps
Outgoing Bandwidth	40Mbps
Remote Users	128
Protocols	P2P, UPnP, NTP, DHCP, PPPoE
<b>Video/Audio Output</b>	
HDMI/VGA Output	HDMI: 1920x1080p /60Hz, 1920x1080p /50Hz, 1600x1200 /60Hz, 1280x1024 /60Hz, 1280x720 /60Hz, 1024x768 /60Hz VGA: 1920x1080p /60Hz, 1920x1080p /50Hz, 1600x1200 /60Hz, 1280x1024 /60Hz, 1280x720 /60Hz, 1024x768 /60Hz
Recording Resolution	1080p/960p/720p/D1/2CIF/CIF
Audio Output	1-ch, RCA
Synchronous Playback	8-ch
Corridor Mode Screen	3/4/5/7/9
<b>Decoding</b>	
Decoding format	Ultra 265/H.265/H.264
Live view/ Playback	1080p/960p/720p/D1/2CIF/CIF

Capability	4 x 1080P@20, 4 x 720P@30, 8 x D1@30				
<b>Hard Disk</b>					
SATA	1 SATA interface				
Capacity	Up to 6TB for each HDD				
<b>External Interface</b>					
Network Interface	1 RJ45 10M/100M self-adaptive Ethernet Interface				
USB Interface	Rear panel: 2 x USB2.0				
<b>Wi-Fi</b>					
Frequency	2.4GHz				
Transmission Rate	150Mbps				
Wireless Standards	IEEE 802.11b/g/n				
Wireless Range	280m(open environment)				
<b>General</b>					
Power Supply	12V DC Power Consumption: ≤ 9 W( without HDD )				
Working Environment	-10°C ~ + 55°C ( +14°F ~ +131°F ), Humidity ≤ 90% RH(non-condensing)				
Dimensions(W×D×H)	205mm ×228mm ×47mm (8.1" × 9.0"×1.9")				
Weight ( without HDD )	≤ 0.98Kg(2.16lb)				
<b>Model</b>	<b>IPC2122SR3-F40W-D</b>				
Sensor	1/2.7", 2.0 megapixel, progressive scan, CMOS				
Lens	4.0mm@F2.0				
DORI Distance	Lens	Detect(m)	Observe(m)	Recognize(m)	Identify(m)
	4mm	60	24	12	6
Angle of view(H)	86.5°				
Angle of View (V)	44.1°				
Angle of View (O)	106.4°				
Adjustment angle	Pan: 0°~360°		Tilt: 0°~90°		Rotate: 0°~360°
Shutter	Auto/Manual, 1 ~ 1/100000s				
Minimum Illumination	Colour: 0.02 Lux (F2.0 AGC ON) 0 Lux with IR on				
Day/Night	IR-cut filter with auto switch (ICR)				
Digital noise reduction	2D/3D DNR				
S/N	>52dB				
IR Range	Up to 30m (98 ft) IR range				
Defog	Digital Defog				
WDR	DWDR				
<b>Video</b>					
Video Compression	Ultra 265, H.265, H.264, MJPEG				
H.264 code profile	Baseline profile, Main Profile				
Frame Rate	Main Stream:2MP (1920×1080): Max. 20 fps; Sub Stream: 720P (1280×720): Max. 20 fps; Third Stream: 4CIF (704×576): Max. 20 fps				
HLC	Supported				
BLC	Supported				
OSD	Up to 4 OSDs				

Privacy Mask	Up to 4 areas
ROI	Up to 2 areas
Motion Detection	Up to 4 areas
<b>Storage</b>	
Edge Storage	Micro SD, up to 256 GB
Network Storage	ANR
<b>Network</b>	
Protocols	IPv4, IGMP, ICMP, ARP, TCP, UDP, DHCP, RTP, RTSP, RTCP, DNS, DDNS, NTP, FTP, UPnP, HTTP, HTTPS, SMTP
Compatible Integration	ONVIF (Profile S, Profile T), API
<b>Wi-Fi</b>	
Wireless Standards	IEEE802.11b/g/n
Frequency Range	2.4 GHz ~ 2.4835 GHz
Channel Bandwidth	20 MHz Support
Modulation Mode	802.11b: CCK, QPSK, BPSK 802.11g/n: OFDM
Security	64/128-bit WEP, WPA-PSK/WPA2-PSK
Transmit Power	802.11b: 17±1.5dBm @11Mbps 802.11g: 14±1.5dBm @ 54Mbps 802.11n: 12.5±1.5dBm
Receive Sensitivity	802.11b: -90dBm @ 11Mbps (Typical) 802.11g: -75dBm @ 54Mbps (Typical) 802.11n: -74dBm (Typical)
Transmission Rate	802.11b: 11Mbps 802.11g: 54Mbps 802.11n: up to 150Mbps
<b>Interface</b>	
Network	1 RJ45 10M/100M Base-TX Ethernet
<b>General</b>	
Power	12 V DC(+/-25%)
	Power consumption: Max 6.4 W
Dimensions (L × W × H)	162.6 x 62.4 x 62.7 mm (6.4"x2.5"x2.5")
Weight	0.25 kg (0.55 lb)
Working Environment	-30°C ~ +60°C (-22°F ~ 140°F), Humidity: ≤95% RH(non-condensing)
Ingress Protection	IP66
Reset Button	Supported

Dimensions

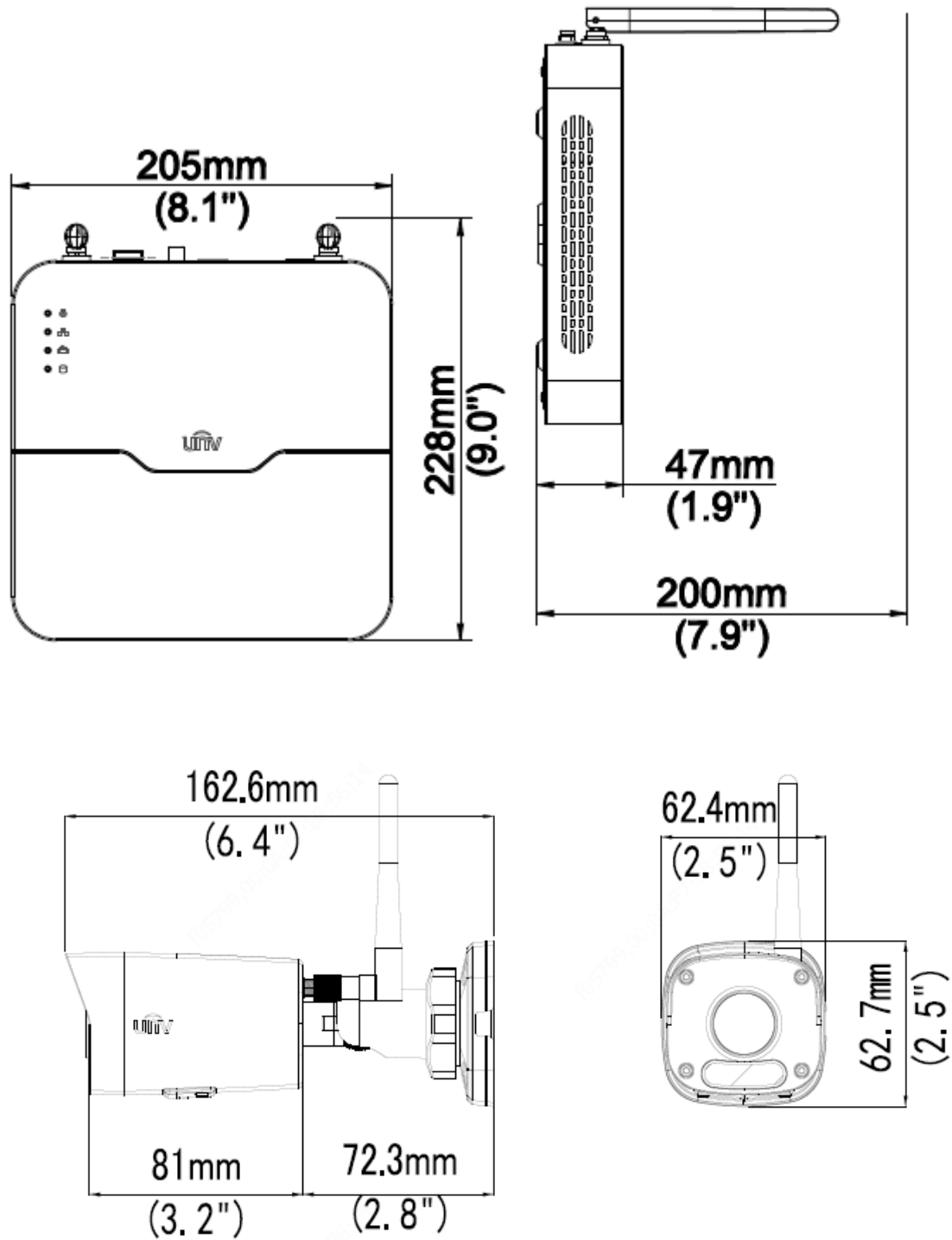

## Rear Panel

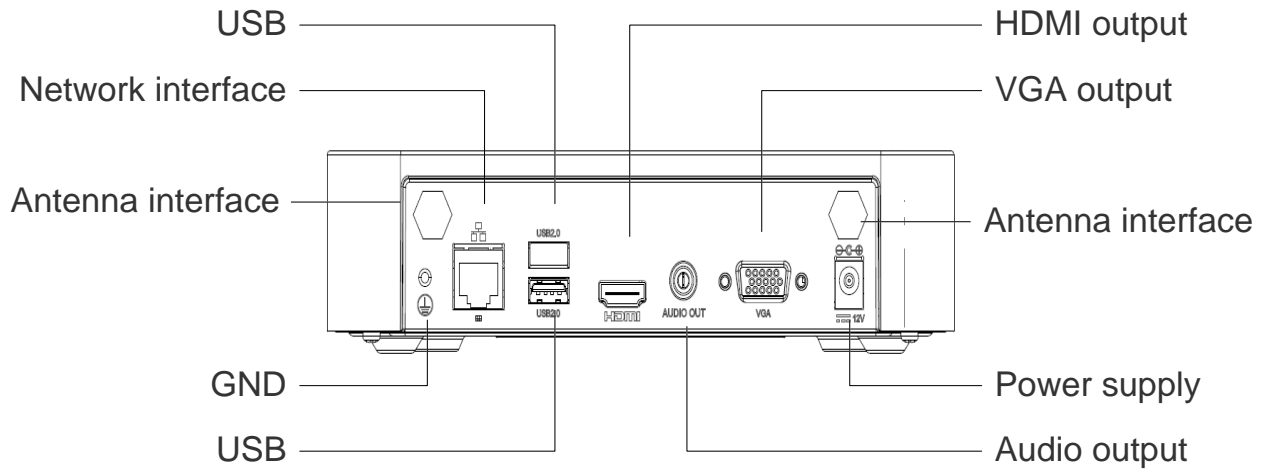

**Zhejiang Uniview Technologies Co., Ltd.**

Building No.10, Wanlun Science Park, Jiangling Road 88, Binjiang District, Hangzhou, Zhejiang, China

Email: [overseasbusiness@uniview.com](mailto:overseasbusiness@uniview.com); [globalsupport@uniview.com](mailto:globalsupport@uniview.com)

<http://www.uniview.com>

©2019 -2020 Zhejiang Uniview Technologies Co.,Ltd. All rights reserved.

\*Product specifications and availability are subject to change without notice.